

INSTALLATION MANUAL



VuTerra Universal Home Theater Stand (PSD-VT)



Table of Contents

WARNING STATEMENTS	4
PARTS LIST	5
INSTALLATION TOOLS	5
SUPPORT TUBE INSTALLATION	8
SHELF ASSEMBLY	9
MOUNT ASSEMBLY	10
TECHNICAL SPECIFICATIONS	11
WARRANTY	12
CONTACT PREMIER MOUNTS	12
NOTES	13



Warning Statements

WARNING: THE FLOOR STRUCTURE MUST BE CAPABLE OF SUPPORTING AT LEAST FIVE (5) TIMES THE WEIGHT OF THE PLASMA DISPLAY. IF NOT, THE FLOOR STRUCTURE MUST BE REINFORCED. PROPER INSTALLATION PROCEDURE BY A QUALIFIED SERVICE TECHNICIAN, AS OUTLINED IN THE INSTALLATION INSTRUCTIONS, MUST BE ADHERED TO. FAILURE TO DO SO COULD RESULT IN SERIOUS PERSONAL INJURY, OR EVEN DEATH.

WARNING: SAFETY MEASURES MUST BE PRACTICED AT ALL TIMES DURING THE INSTALLATION OF THIS PRODUCT. USE PROPER SAFETY GEAR AND TOOLS FOR THE INSTALLATION PROCEDURE TO PREVENT PERSONAL INJURY.

WARNING: PRIOR TO THE INSTALLATION OF THIS PRODUCT, THE INSTALLATION INSTRUCTIONS SHOULD BE READ AND COMPLETELY UNDERSTOOD. THE INSTALLATION INSTRUCTIONS MUST BE READ TO PREVENT PERSONAL INJURY AND PROPERTY DAMAGE. KEEP THESE INSTALLATION INSTRUCTIONS IN AN EASILY ACCESSIBLE LOCATION FOR FUTURE REFERENCE.



Indicates that the power plug is to be disconnected from the power outlet.



Contact Premier Mounts with any questions.



Safety precautions must be taken at all times.



Warning and Caution statements.



Do not install on a structure that is prone to vibration, movement or chance of impact. Failure to do so could result in damage to the plasma display and/or damage to the mounting surface.



Do not install near heater, fireplace, direct sunlight, air conditioning or any other source of direct heat energy. Failure to do so may result in damage to the plasma display and could increase the risk of fire.



At least two qualified people should perform the installation procedure. Injury and/or damage can result from dropping or mishandling the plasma display.



Parts List

NOTE: This floor stand is shipped with all proper installation hardware and components. Make sure that none of these parts are missing and/or damaged before beginning installation. If there are parts missing and/or damaged, please stop the installation and contact Premier Mounts (800-368-9700).

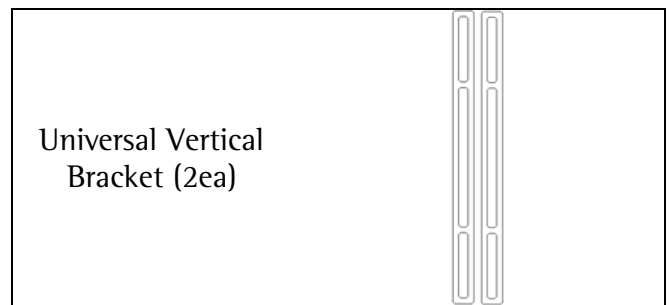
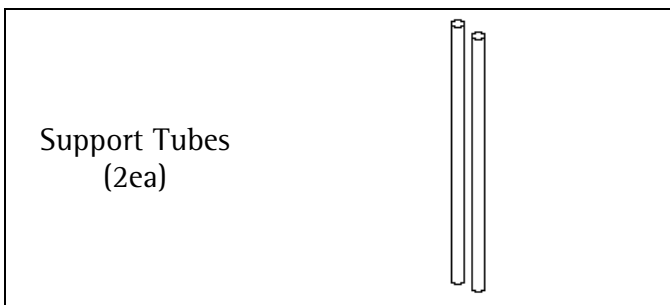
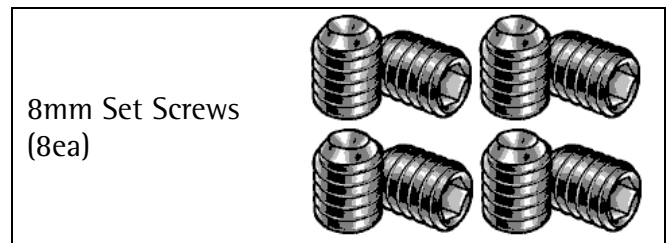
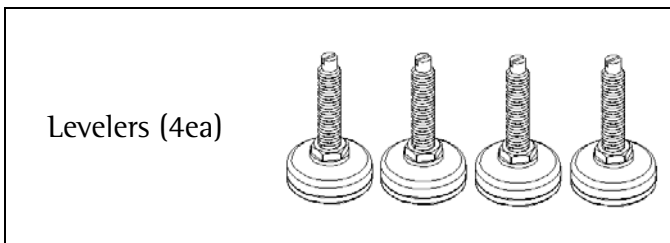
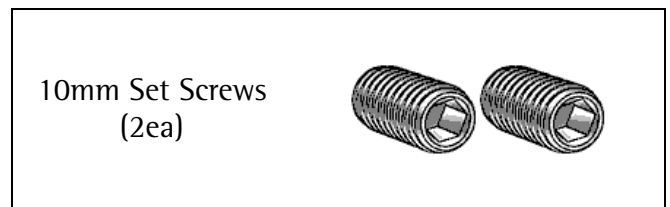
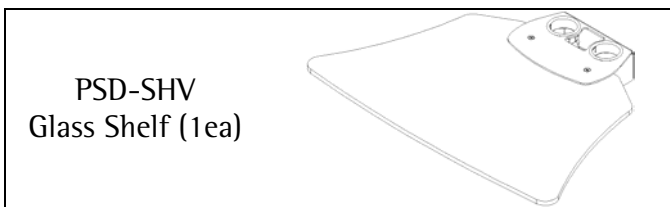
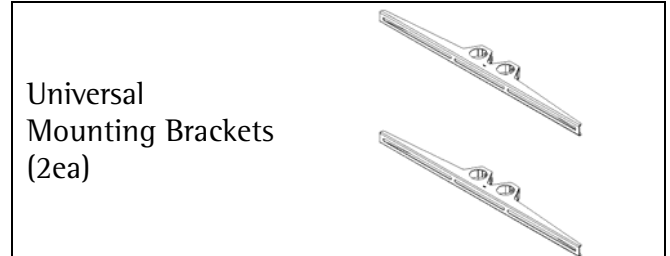
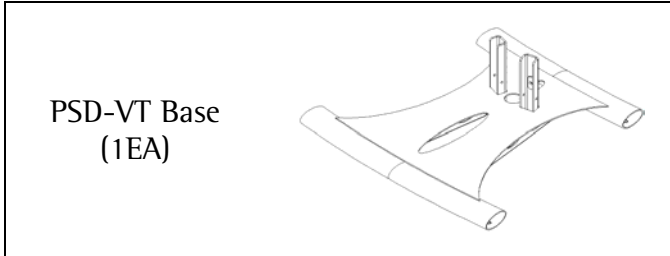

Installation Tools

Phillips Head Screw Driver
Soft Material/ Blanket

Portable Drill
Pencil

1/4" Drill Bit
Tape Measure

Allen Wrench
Wrench with 1/2" Drive Socket



Parts List (Cont.)

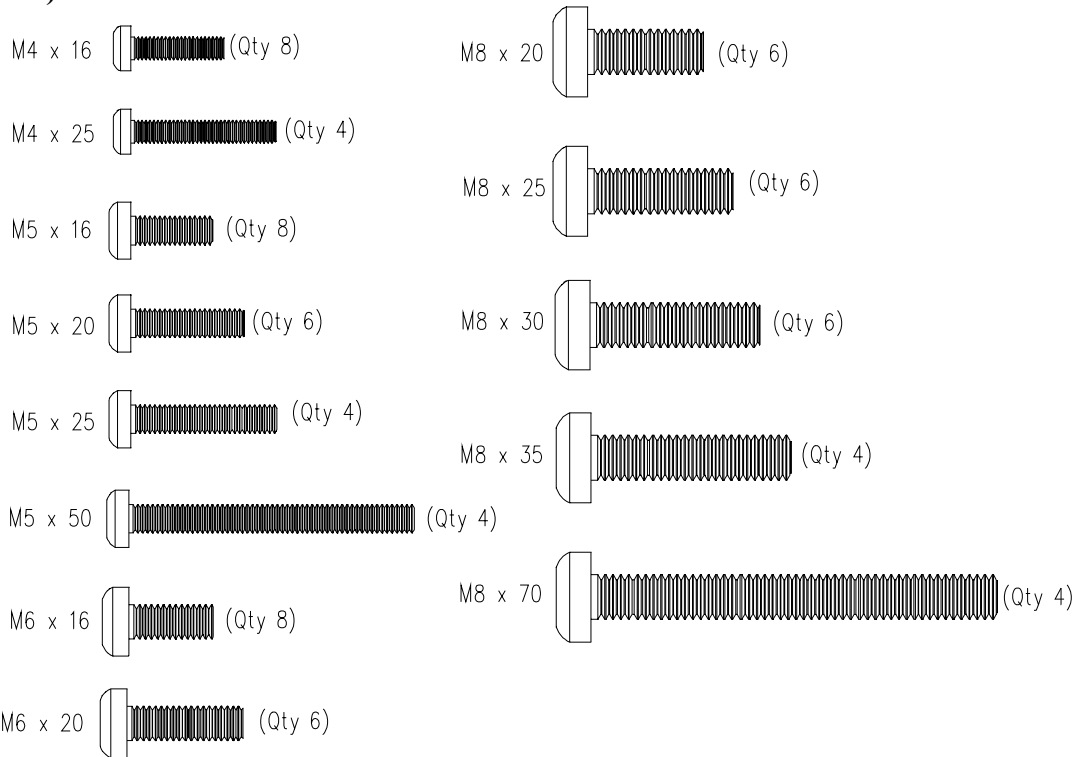

Thread Depth Indicator Use

1. Insert the thread depth indicator (supplied) through the thread inserts found on the back of the flat panel to make sure the inserts measure the same full depth and mark it.
(see Figure 1)
2. Locate the correct diameter screw for the thread insert. Compare your marking to the screws (supplied). If your selected screw is longer than the marking on the thread depth indicator **DO NOT USE** this screw. The screw length must not bypass the marking. Select another screw size
(see Figure 2 and 3). Until you find one that comes closest to your mark without going past

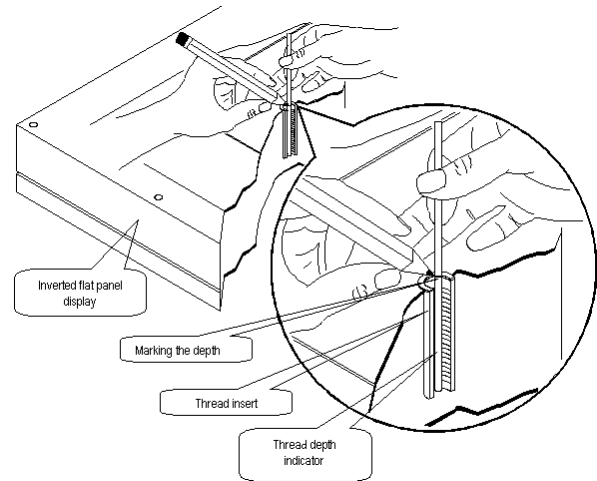

Figure 1

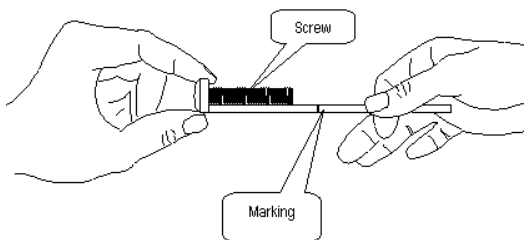

Figure 2

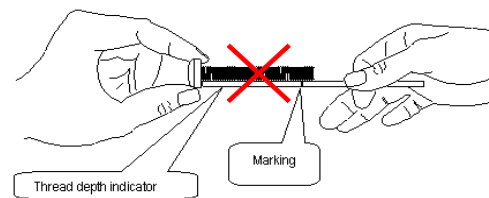
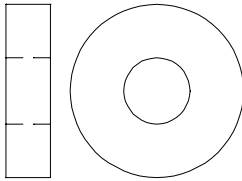

Figure 3



NOTE: The nylon spacers may be stacked to achieve proper spacing.



1/4" Nylon spacers
(large)
(Qty 6)

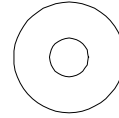
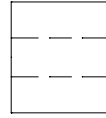

9/16" Nylon spacers
(Qty 6)

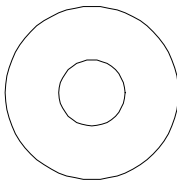
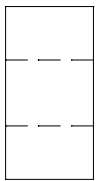

1/2" Nylon spacers
(large)
(Qty 12)

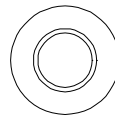
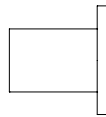

Nylon sleeves
(Qty 4)

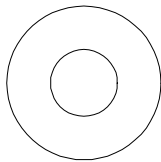
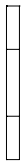

5/16" Flat washers
(metal)
(Qty 6)

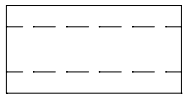

1" Nylon spacers
(Qty 6)

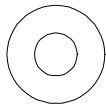
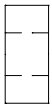

1/4" Nylon spacers
(small)
(Qty 6)



Support Tube Installation

1. Place the PSD-VT base on a flat surface.
2. Take the support tubes and slide them over the mounting clamps that are located on the PSD-VT base.

NOTE: To perform the following step, the access holes that are located at the end of the support tubes must line up with the setscrew holes on the clamps.

3. Insert the set screws into each hole and tighten with an Allen wrench (Figure 4).

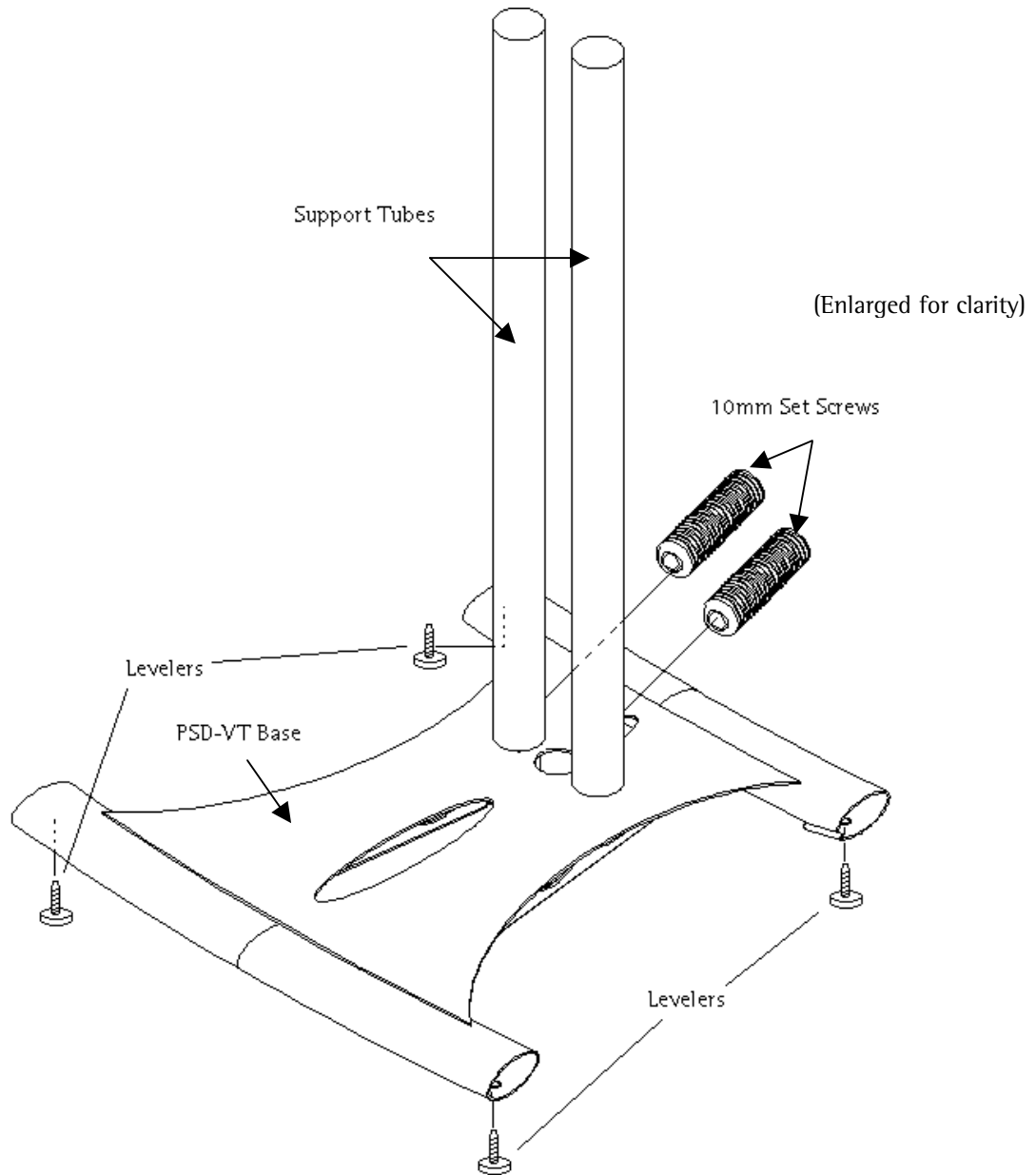

Figure 4. Support Tube Installation



Shelf Assembly

1. Slide the shelf assembly over and down the support tubes.
2. Determine the desired height of the shelf.
3. After the height has been determined, use four (4) 8mm set screws to lock the shelf assembly in place.
4. Tighten using an Allen wrench (Figure 5).

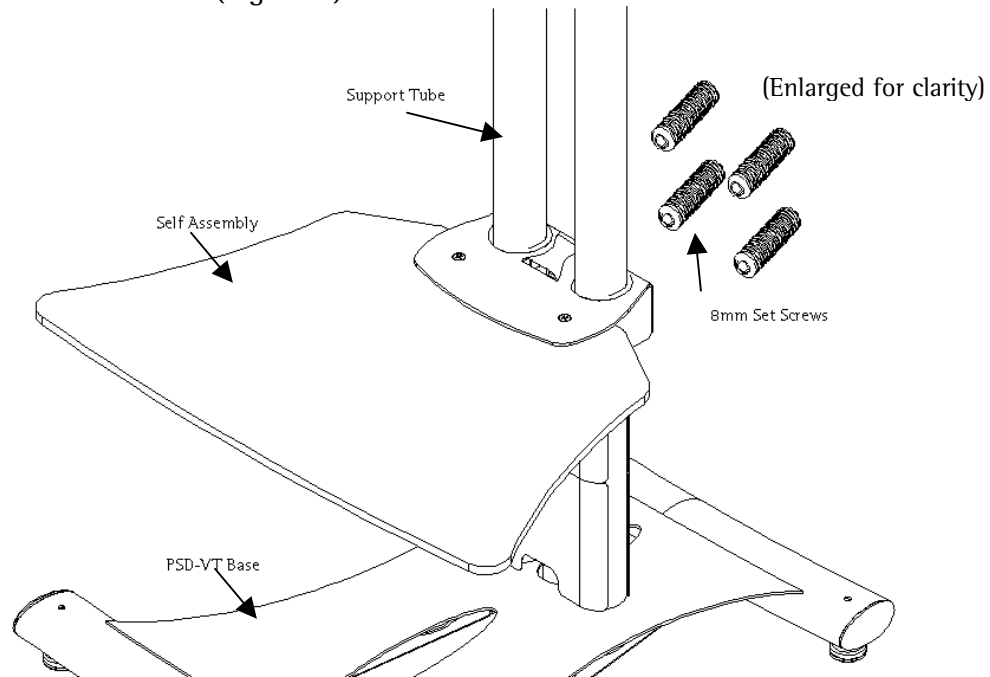

Figure 5. Shelf Assembly



Mount Assembly

1. Slide one mounting bracket over and down the support tubes. This will be the lower mounting bracket. For the time being, let the bracket rest on the shelf assembly.
2. Place the display on a flat, soft surface. Locate the mounting points that are located on the back of the display.
3. Once the mounting points are located, place both universal vertical brackets over the mounting points.
4. Place the upper mounting bracket over the upper mounting points and secure the bracket to the display using the provided hardware. **DO NOT OVERTIGHTEN.**

CAUTION: It is recommended that two people perform the following step.

5. Lift the display up and slide the upper mounting bracket over and down the support tubes.
6. Select the desired height. Insert and tighten the mounting bracket set screws.
7. Slide the lower mounting bracket up and attach the bracket to the display using the provided hardware.
8. Once the bracket has been attached to the display, insert and tighten the mounting bracket set screws.
9. Once the floor stand has been completely assembled, attach the magnetic support tube covers, front and back.

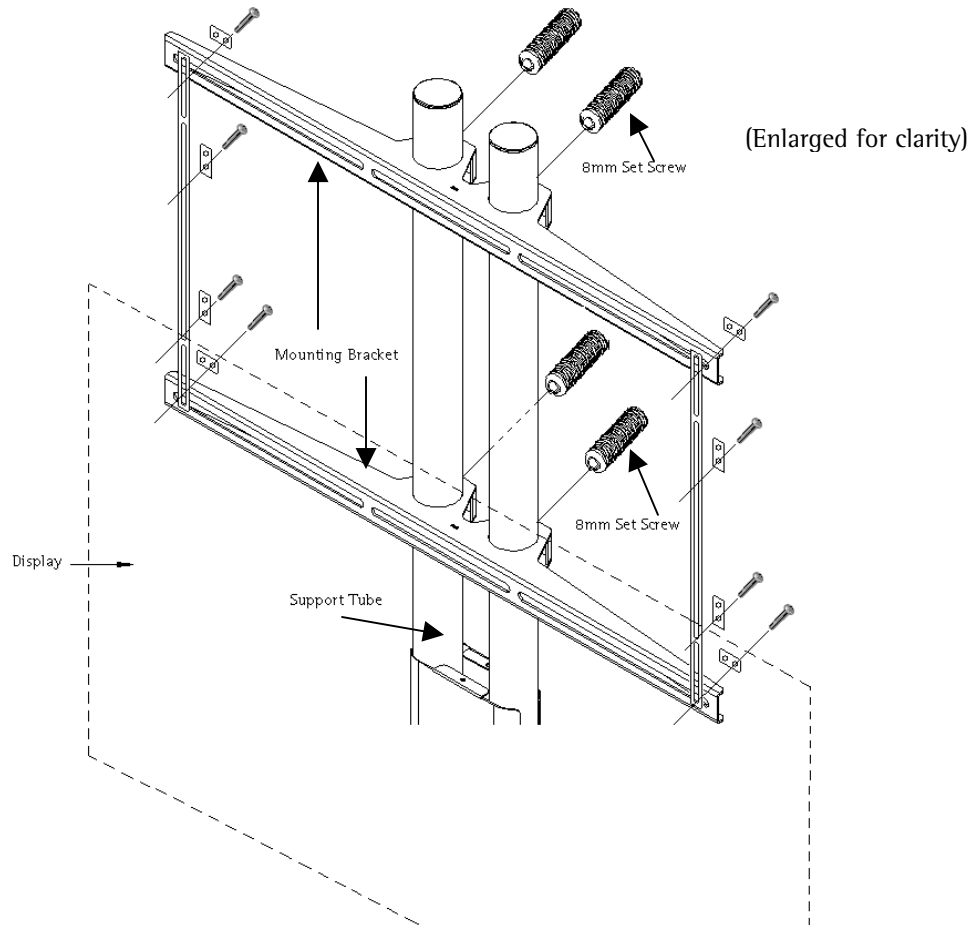

Figure 6. Mounting Bracket Installation



Technical Specifications

NOTE: All dimensions given are including the mount covers. This must be taken into consideration when measuring for the mount location.

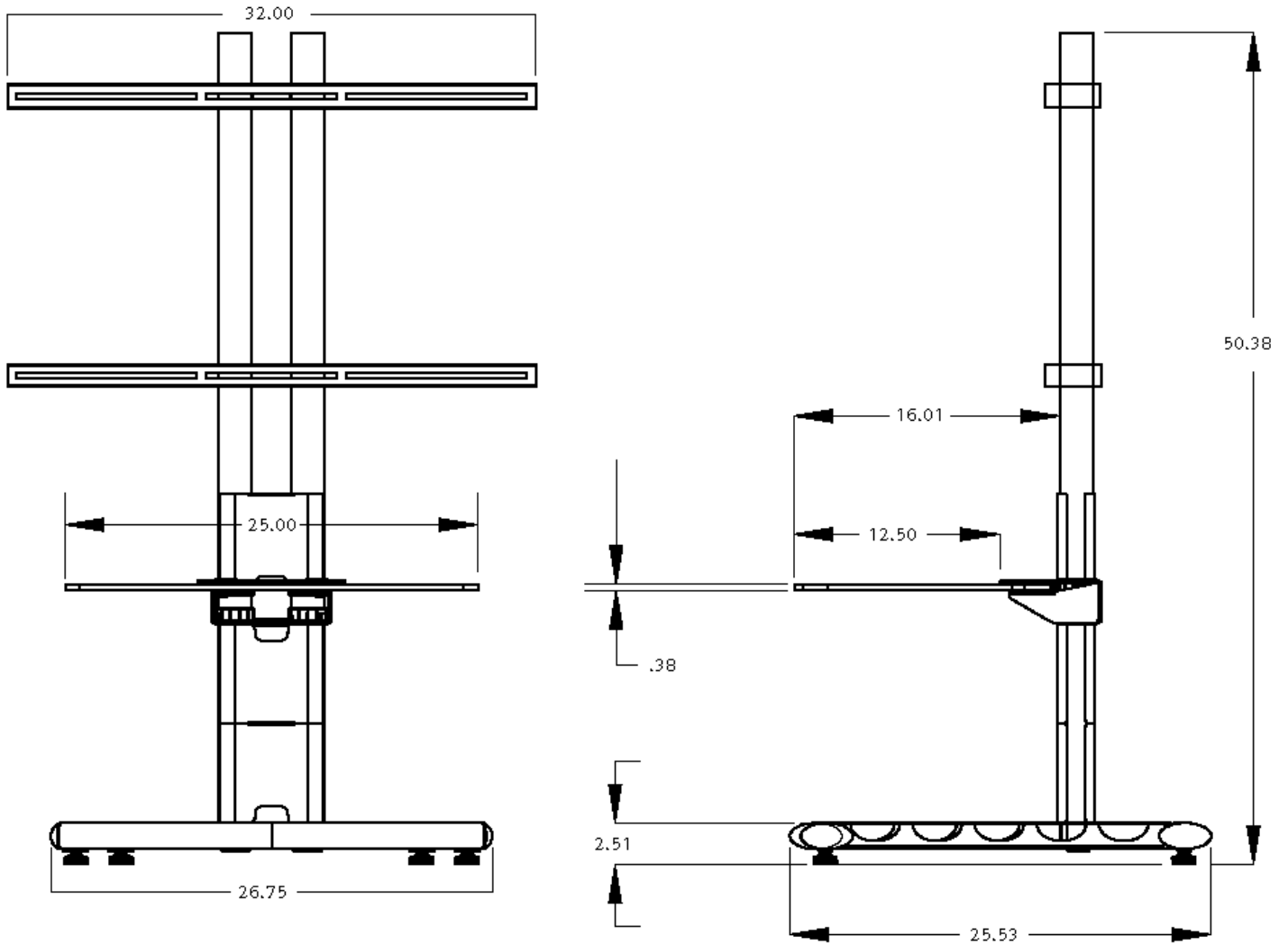

Figure 7. Technical Specifications



Warranty

Limited Lifetime Warranty

All Premier Mounts products carry a limited lifetime warranty from ship date against defects in materials and workmanship. Premier Mounts is not liable for improper installation that results in damage to mounts, adapters, display equipment or personal injury.

Contact Premier Mounts

In the event of missing and/or damage equipment, or technical questions, the following information can help in the completion of the installation.

Customer Service – (800) 368-9700

Technical Support – techsupport@mounts.com



Notes

NORTH AMERICA

3130 East Miraloma Avenue
Anaheim, CA 92806 USA
USA and Canada –
Phone: 800-368-9700
Fax: 800-832-4888

EUROPE

Swallow House,
Shilton Industrial Estate,
Shilton, Coventry, England CV79JY
Phone: +44 (0) 2476 614700
Fax: +44 (0) 2476 614710

ASIA

Nakaizumi 607-7,
Gunma-machi, Gunma-gun
Gunma-ken 370-3524, Japan
Phone: 81.27.371.6998
Fax: 81.27.371.6308

Other Locations – Phone: 001.714.632.7100; Fax: 001.714.632.1044

©Premier Mounts 2005